



# Diva Air Vetro

---

Sliding system for glass doors with amortized stopper  
Scorrevoli per porte in vetro con fermo ammortizzato



# Diva Air Vetro

**PATENTED**

**Diva Air Vetro** is the **patented sliding system** with exposed aluminium track and soft-closing, for glass design doors.

**Diva Air Vetro** is featured by **minimal style, thanks to hidden sliding trolleys**. Patented air dampers are totally concealed into the tracks, in order to **stand out the design of the door**. The exposed aluminium tracks is available in various finishing solutions.

**Diva Air Vetro** è l'innovativo **sistema scorrevole brevettato** con fermi ammortizzati per porte in vetro di design.

Caratterizzato da **linee minimaliste**, il sistema **Diva Air Vetro** con scorrimento frontale **esalta il design della porta**, grazie agli scorrevoli che risultano nascosti. Il binario, parzialmente nascosto dalla porta, è disponibile in varie finiture.



# Diva Air Vetro

Sliding system with amortized stopper  
Scorrevoli per porte con fermo ammortizzato

## Easy mounting



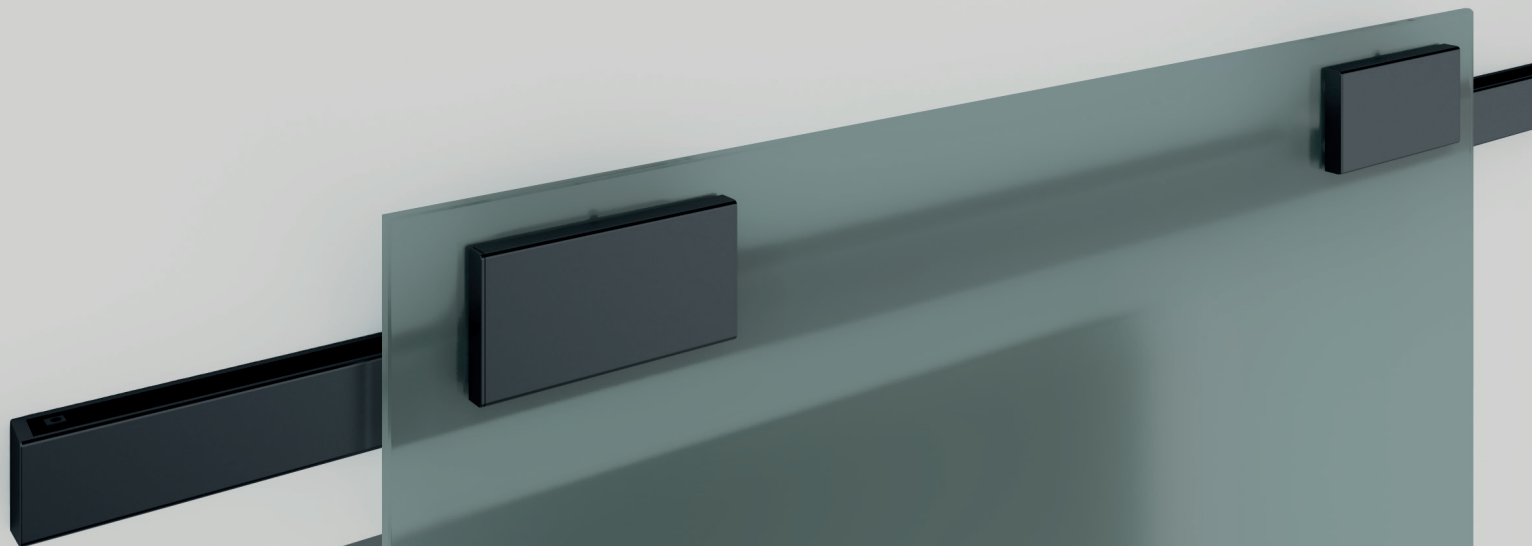

The air damper is integrated into the track and is equipped with an automatic loading system; the pre-loading operation must be made before the first usage of the door.

## Facile da montare

L'ammortizzatore è inserito nel binario ed è dotato di caricamento automatico, da eseguire prima dell'utilizzo della porta.



**PATENTED**

<b>Diva Air Vetro</b>		COMPLETE BOX KIT / KIT COMPLETO IN SCATOLA		
<b>K</b>	Complete <b>Diva Air</b> kit for N°1 glass door / Kit completo <b>Diva Air</b> per N°1 porta in vetro			
	0061		Wall distance <b>31 mm</b> Distanza dal muro <b>31 mm</b>	
	0062		Wall distance <b>31 mm</b> Distanza dal muro <b>31 mm</b>	
		<b>1</b>	N.2 Standard stoppers N.2 Fermi standard	
		<b>2</b>	N.2 Soft damper stoppers N.2 Fermi ammortizzati	
				<b>01</b> Anodized Silver / Argento
				<b>14</b> Anodized Black / Nero
				<b>16</b> Anodized Nickel / Nichel
				<b>26</b> Anodized Graphite / Grafite

**EXAMPLE / ESEMPIO**

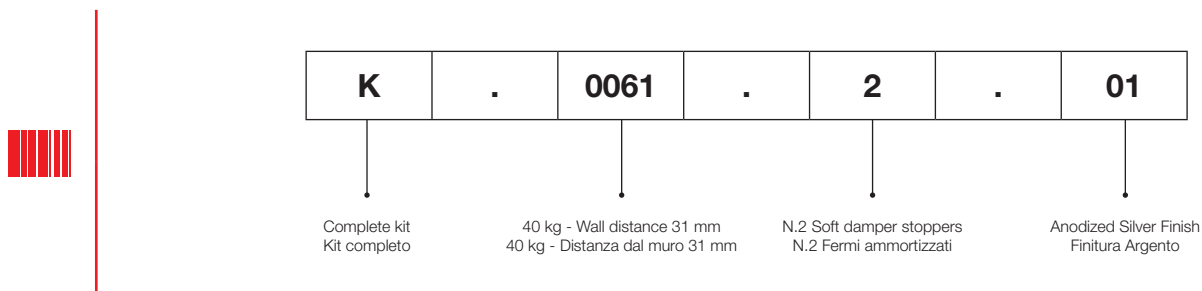

<b>Tracks / Binari</b>		ALUMINUM FINISHES CODES / CODICI FINITURE ALLUMINIO		
CODE / CODICE		FINISH COLOR / COLORE FINITURA		
8 00 0.0 .....		<b>00 G</b>	Raw / Mill Finish / Neutro / Grezzo	<b>STANDARD</b>
8 01 0.0 .....		<b>01 A</b>	Anodized Silver / Argento	
8 02 0.0 .....		<b>02 AS</b>	Brushed Anodized Silver / Argento Spazzolato	
8 14 0.0 .....		<b>14 N</b>	Anodized Black / Nero	<b>SPECIAL</b>
8 15 0.0 .....		<b>15 NS</b>	Brushed Anodized Black / Nero Spazzolato	
8 16 0.0 .....		<b>16 NK</b>	Anodized Nickel / Nichel	
8 17 0.0 .....		<b>17 NKS</b>	Brushed Anodized Nickel / Nichel Spazzolato	
8 25 0.0 .....		<b>25 GRFS</b>	Brushed Anodized Graphite / Grafite Spazzolato	
8 26 0.0 .....		<b>26 GRF</b>	Anodized Graphite / Grafite	

# Diva Air Vetro

Sliding system with amortized stopper  
Scorrevoli per porte con fermo ammortizzato

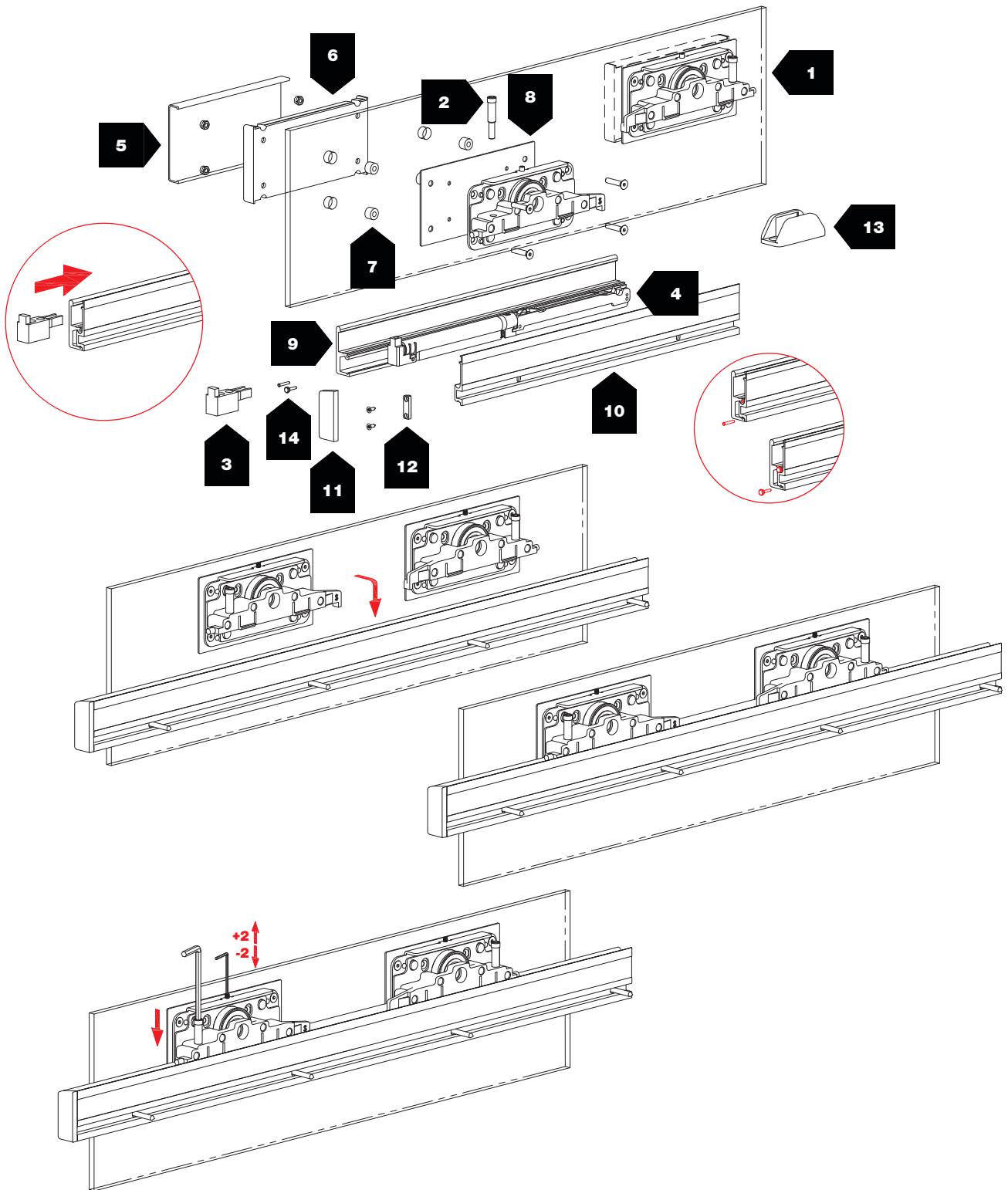

31 mm



40 - 80 kg



10 mm

## COLORS / COLORI

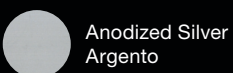

Anodized Silver  
Argento

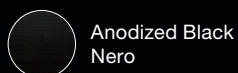

Anodized Black  
Nero

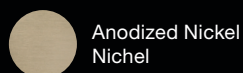

Anodized Nickel  
Nichel

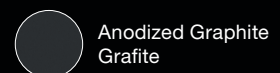

Anodized Graphite  
Grafite

N°	Barcode	Image	kg		N°	Barcode	Image	kg	
1	1478		40÷80		8	1482		-	
2	1479		-		9	1470 8 02 0.01470		-	
3	1473		40		10	1450 8 01 2.01450		-	
	1477		80						
4	1476/35G		40		11	1474		-	
	1476/80Y		80		12	1472		-	
5	1349/161		-		13	1486/8/10/12		-	
6	1484		-		14	1337		-	
7	1341		-			1333		-	

# Diva Air Vetro

Sliding system with amortized stopper  
Scorrevoli per porte con fermo ammortizzato

 N.2 Soft damper stoppers  
N.2 Fermi ammortizzati

 Patented system  
Sistema brevettato

 Ball bearings  
Cuscinetti a sfera



**.01** Anodized Silver  
Argento

**.14** Anodized Black  
Nero

**.16** Anodized Nickel  
Nichel

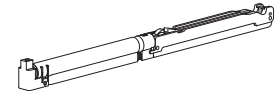
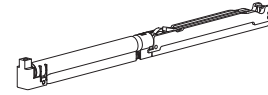
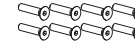
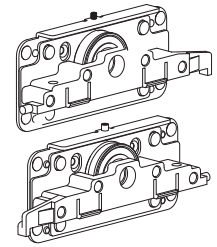
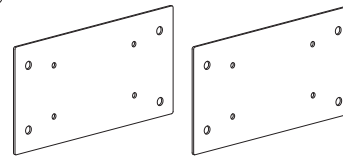
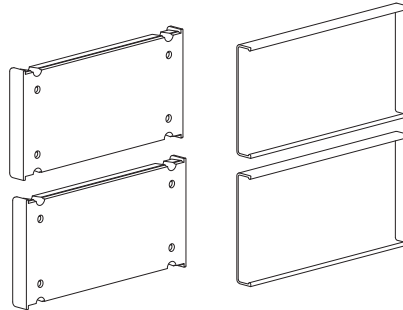
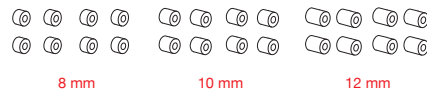
**.26** Anodized Graphite  
Grafite



OLD CODE	NEW CODE	COLORS COLORI			
1478/1349/35GA	K.0061.2.01	Anodized Silver / Argento	<b>40 kg</b>	31 mm	6x
1478/1349/35GN	K.0061.2.14	Anodized Black / Nero			6x
—	K.0061.2.16	Anodized Nickel / Nichel			6x
—	K.0061.2.26	Anodized Graphite / Grafite			6x
1478/1349/80YA	K.0062.2.01	Anodized Silver / Argento	<b>80 kg</b>	31 mm	6x
1478/1349/80YN	K.0062.2.14	Anodized Black / Nero			6x
—	K.0062.2.16	Anodized Nickel / Nichel			6x
—	K.0062.2.26	Anodized Graphite / Grafite			6x

 N.2 Standard stoppers  
N.2 Fermi standard

 Patented system  
Sistema brevettato

 Ball bearings  
Cuscinetti a sfera



**.01** Anodized Silver  
Argento

**.14** Anodized Black  
Nero

**.16** Anodized Nickel  
Nichel

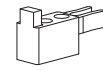
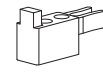
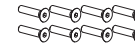
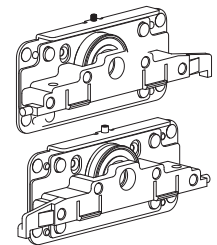
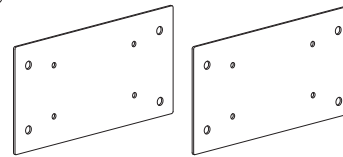
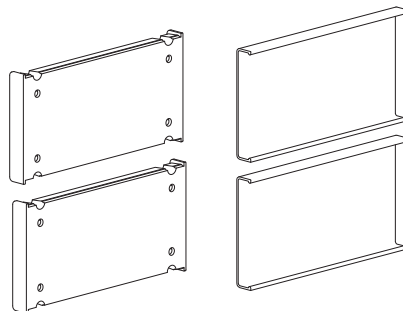
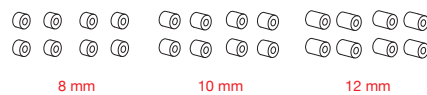
**.26** Anodized Graphite  
Grafite



OLD CODE	NEW CODE	COLORS COLORI			
1478/1349/P40/A	K.0061.1.01	Anodized Silver / Argento	<b>40 kg</b>	31 mm	6x
1478/1349/P40/N	K.0061.1.14	Anodized Black / Nero			6x
—	K.0061.1.16	Anodized Nickel / Nichel			6x
—	K.0061.1.26	Anodized Graphite / Grafite			6x
1478/1349/P80/A	K.0062.1.01	Anodized Silver / Argento	<b>80 kg</b>	31 mm	6x
1478/1349/P80/N	K.0062.1.14	Anodized Black / Nero			6x
—	K.0062.1.16	Anodized Nickel / Nichel			6x
—	K.0062.1.26	Anodized Graphite / Grafite			6x



## STANDARD HOLES AND MEASUREMENTS / FORATURE E MISURE STANDARD

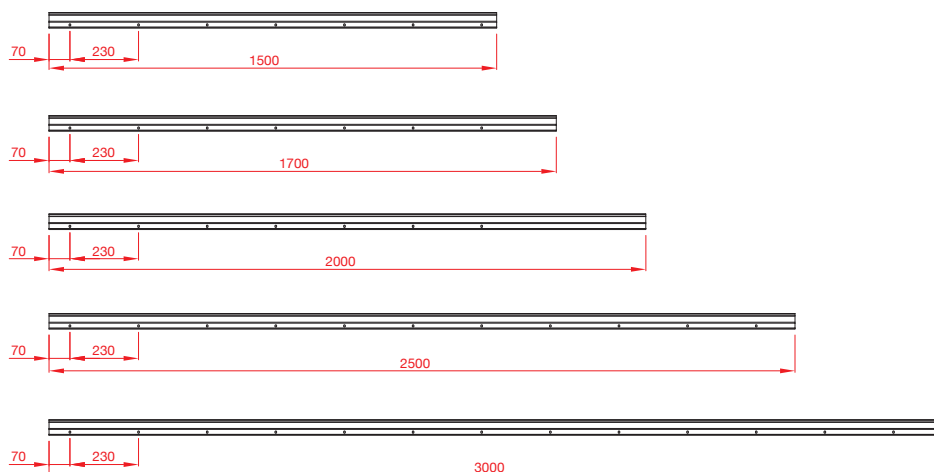

## HOLES AND SIZES ON REQUEST / FORATURE E MISURE A RICHIESTA

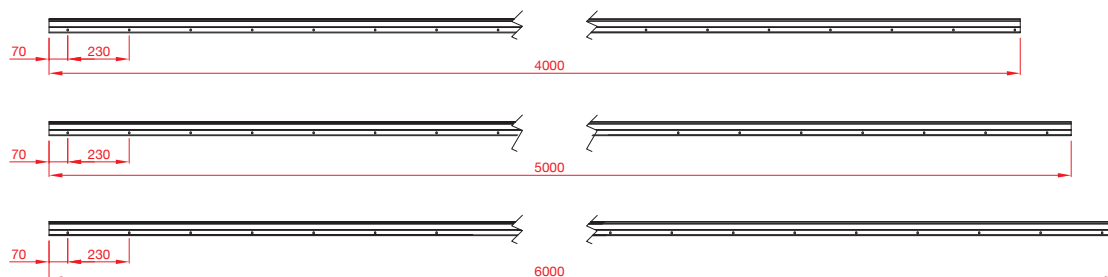

## TRACKS / SPECIFY ARTICLE NUMBER, LENGTH AND COLOR WHEN ORDERING BINARI / AL MOMENTO DELL'ORDINE SPECIFICARE ARTICOLO, LUNGHEZZA E COLORE



**ART. 1470**  
8 02 0.01470  
8 15 0.01470  
8 17 0.01470  
8 25 0.01470



**ART. 1450**  
8 01 2.01450  
8 14 2.01450  
8 16 2.01450  
8 26 2.01450

<b>01</b>	Anodized Silver Argento
<b>02</b>	Brushed Anodized Silver Argento Spazzolato
<b>14</b>	Anodized Black Nero
<b>15</b>	Brushed Anodized Black Nero Spazzolato
<b>16</b>	Anodized Nickel Nichel
<b>17</b>	Brushed Anodized Nickel Nichel Spazzolato
<b>25</b>	Brushed Anodized Graphite Grafite Spazzolato
<b>26</b>	Anodized Graphite Grafite

## STANDARD HOLES AND MEASUREMENTS / FORATURE E MISURE STANDARD

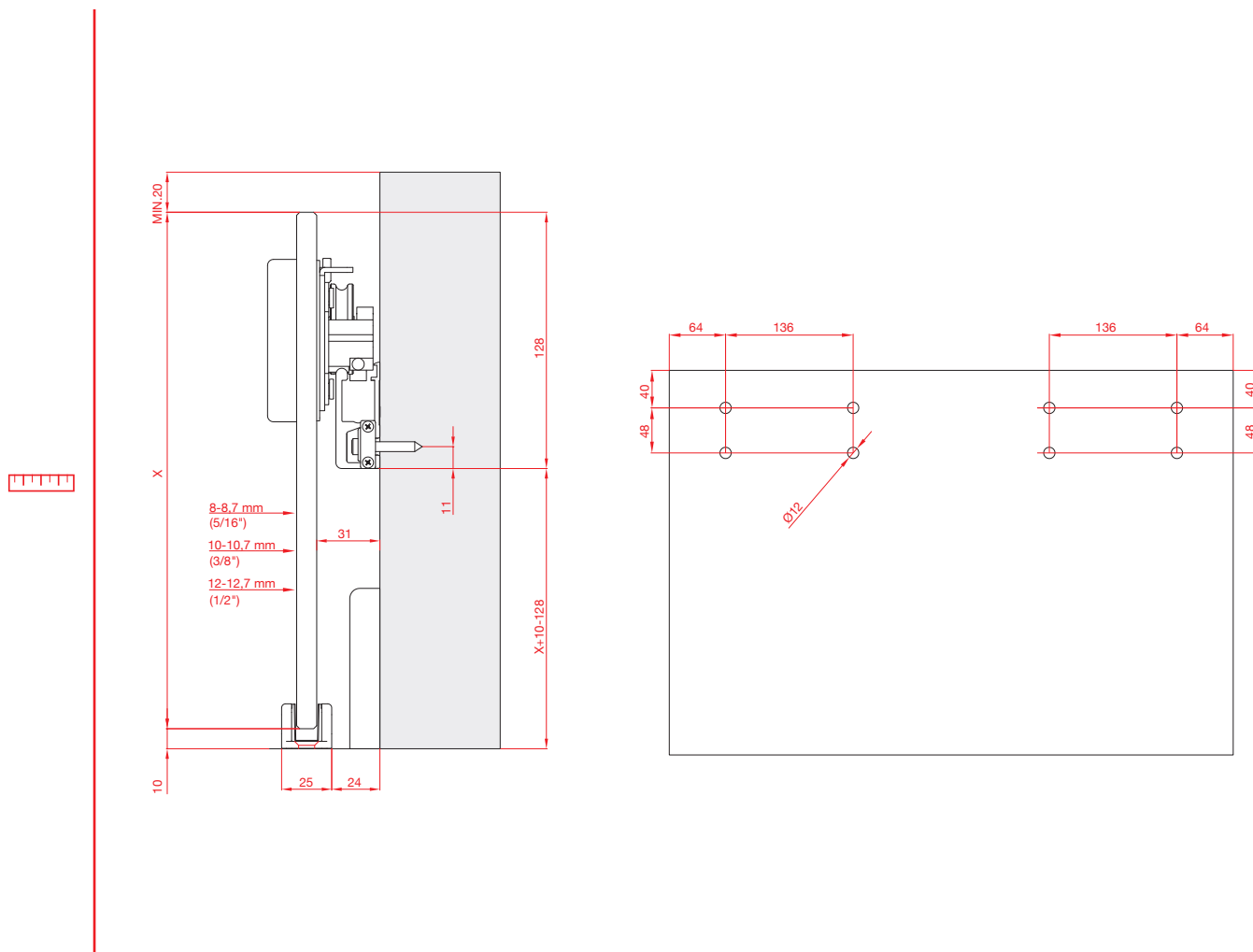



## **Terno Scorrevoli S.p.A.**

**Via Ravenna, 4 - 20814 Varedo (MB) ITALY  
Phone +39 0362 543001 - Fax +39 0362 582290**

**[terno@ternoscorrevoli.com](mailto:terno@ternoscorrevoli.com)  
[www.ternoscorrevoli.com](http://www.ternoscorrevoli.com)**